

Detail B  
Scale: 4:1

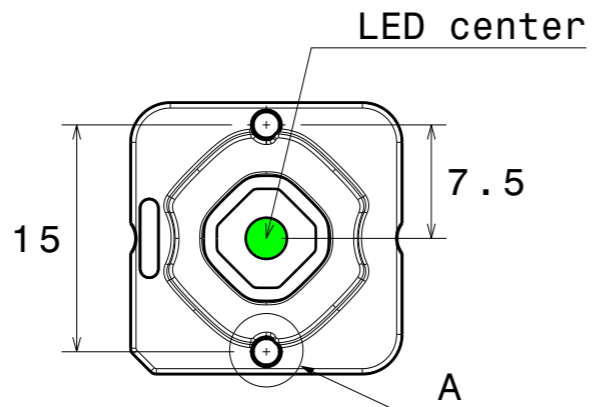

Bottom view  
Scale: 2:1

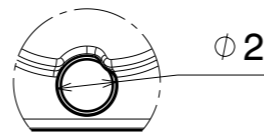

Detail A  
Position pin  
Scale: 4:1

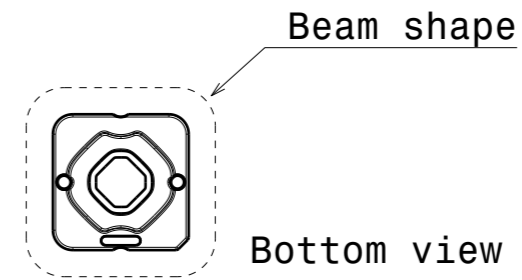

Bottom view  
Scale 1:1

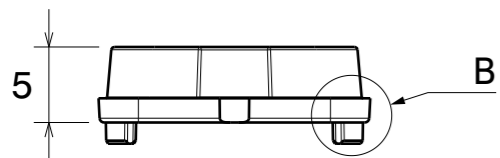

Right view  
Scale: 2:1

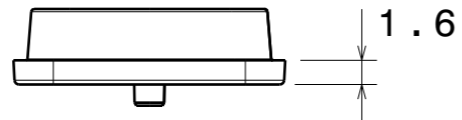

Front view  
Scale: 2:1

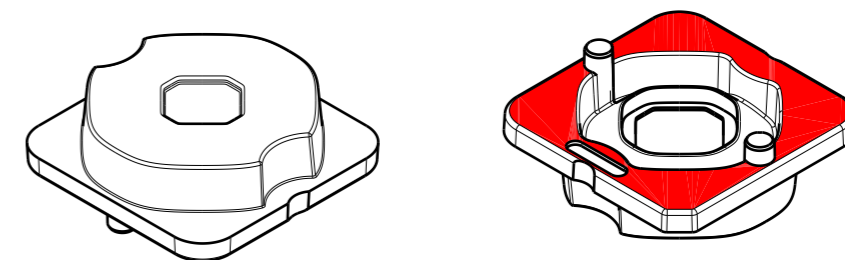

Isometric view  
Scale: 2:1

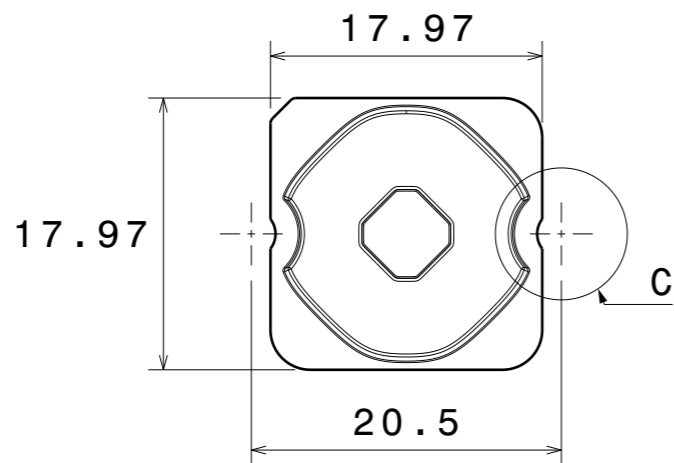

Top view  
Scale: 2:1

Screw distance  
C-C

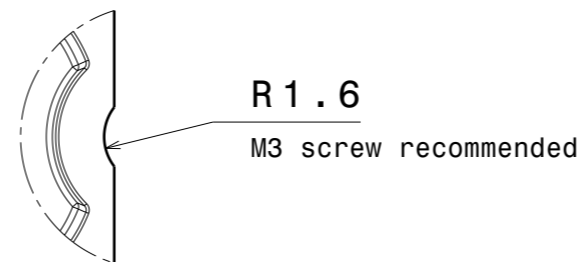

Detail C  
Scale: 4:1

PART	TYPE	MATERIAL	COLOR / COATING
C16734_SITARA-HB-S	Lens	PMMA	transparent

**MECHANICAL DRAWING**

PRODUCT  
**SITARA**

Plastic moulding general tolerances according to DIN 16901-130 and applies if not otherwise shown in the drawing. Silicone moulding general tolerances according to ISO 3302-1 Class M3 and applies if not otherwise shown in the drawing.

FIRST ANGLE PROJECTION:

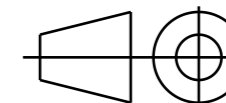

**LEDiL®**

This drawing is the property of LEDiL Oy. It may not be copied or otherwise distributed without prior written permission from LEDiL Oy.

SCALE 2:1

WEIGHT 1 g

A3 SHEET 1/1

**Notes**

	PCB or heatsink level.
	LED location
	Ensure LED fitting from a product specific 3D model available from <a href="http://www.ledil.com">www.ledil.com</a>
	For more details about installation please see LEDiL Installation Guide on <a href="http://www.ledil.com">www.ledil.com</a>